

REVISIONS				
REV.	ECO. NO	DESCRIPTION	DATE	BY
A	1750	INITIAL RELEASE	7-10-08	MNH

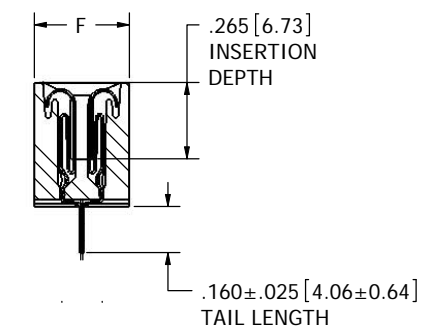

SECTION A - A

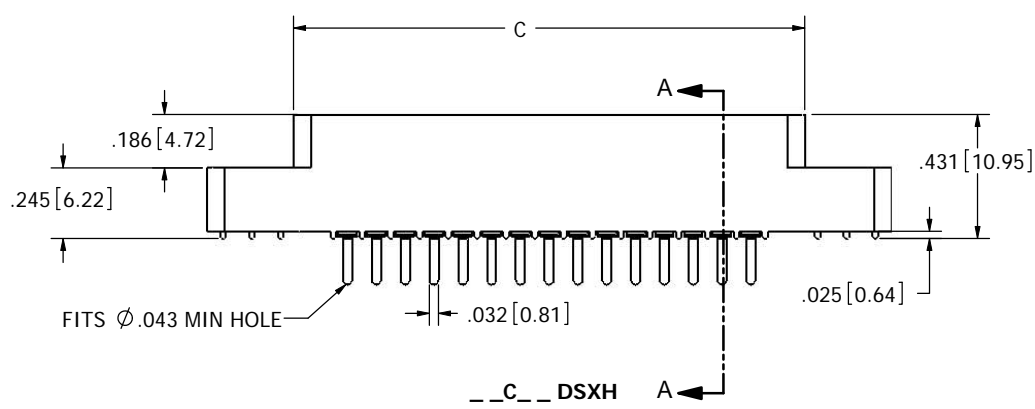
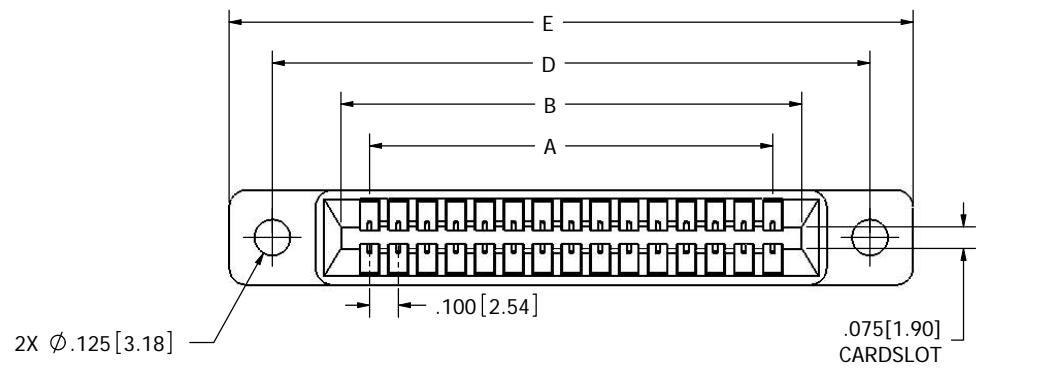
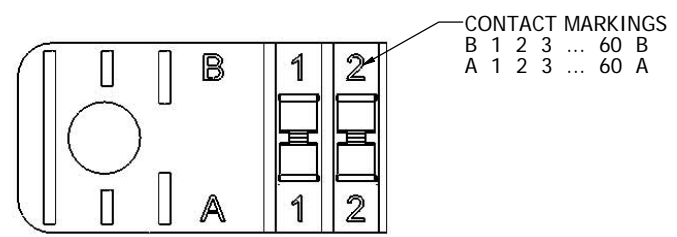

- NOTES:
1. INSULATOR MATERIAL: SEE PART NUMBER CODING
  2. CONTACT MATERIAL: SEE PART NUMBER CODING
  3. PLATING: SEE PART NUMBER CODING
  4. OPERATING TEMPERATURE: SEE PART NUMBER CODING
  5. PROCESSING TEMP: SEE PART NUMBER CODING
  6. UL FLAMMABILITY RATING: 94V-0
  7. VOLTAGE RATING: 600 VDC MINIMUM AT SEA LEVEL.
  8. CURRENT RATING: 3 AMP PER CONTACT
  9. VOLTAGE DROP: 30 MILLI VOLT AT RATED CURRENT
  10. INSULATION RESISTANCE: 5000 MEGA OHM
  11. CONNECTOR IDENTIFICATION: THE PART SHALL BE MARKED WITH A PART NUMBER AND BARCODE
  12. BOARD THICKNESS ACCOMMODATED: .062 ± .008"
  13. BOARD INSERTION FORCE: 16 OZ MAX PER CONTACT PAIR WHEN USING A .062" TEST BLADE. INTERNAL INSPECTION TO BE PER SULLIN'S WORK INSTRUCTION W17.3-01.
  14. BOARD WITHDRAWAL FORCE: 1 OUNCE MINIMUM PER CONTACT PAIR USING .062" PCB

CONTACT ID SCALE 2:1

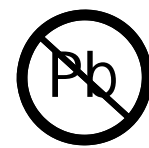

RoHS COMPLIANT

CUSTOMER COPY

UNLESS OTHERWISE SPECIFIED: DIMENSIONS ARE IN INCHES[MM] TOLERANCES: ANGULAR: ± 30° XX ± .02 [508] XXX ± .005 [1270] XXXX ± .0005 [0127] SURFACE FINISH: 6.3 Ra REMOVE ALL BURRS AND SHARP EDGES .010 MAX			DATE 7-10-08	NAME MNH	
THE INFORMATION HEREIN CONTAINS PROPRIETARY INFORMATION OF SULLINS ELECTRONICS AND IS NOT TO BE REPRODUCED, USED OR DISCLOSED TO OTHERS FOR ANY PURPOSE EXCEPT AS SPECIFICALLY AUTHORIZED IN WRITING BY AN OFFICER OF SULLINS ELECTRONICS.			DESCRIPTION CONNECTOR, .100 CC LP		
INTERPRET DIMENSIONS AND GEOMETRIC TOLERANCING PER: ANSI Y14.5M-1994			PART NUMBER --C-- DSXH		SIZE C
			DWG. NO. C11127		REV A
			SCALE: 2:1		SHEET 1 OF 3

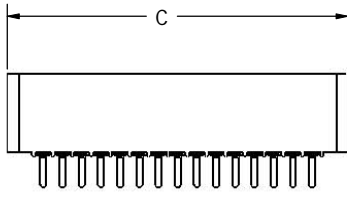

--C--DSXN

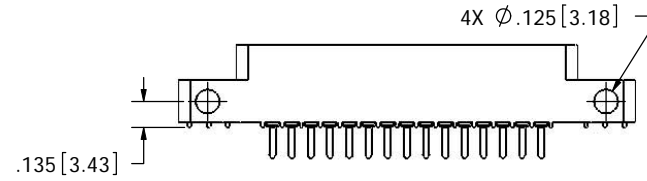

--C--DSXS

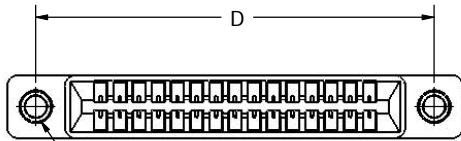

2X #4-40 THREADED INSERTS

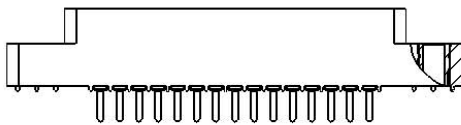

--C--DSXI

2X FLOATING BOBBIN  
Ø .116 [2.95] CLEARANCE  
FOR # 4 SCREW

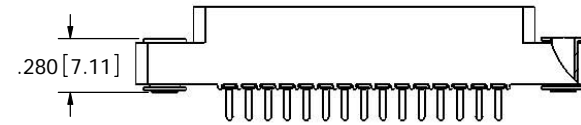

--C--DSXF

## CUSTOMER COPY



RoHS COMPLIANT

UNLESS OTHERWISE SPECIFIED:  
DIMENSIONS ARE IN INCHES[MM]  
TOLERANCES:  
ANGULAR: ± 30'  
XX ± .02 [508]  
XXX ± .005 [1270]  
XXXX ± .0005 [0127]  
SURFACE FINISH: 6.3 Rz  
REMOVE ALL BURRS AND SHARP EDGES .010 MAX

INTERPRET DIMENSIONS AND GEOMETRIC TOLERANCING PER: ANSI Y14.5M-1994

DRAWN	DATE	NAME
MNH	7-10-08	

THE INFORMATION HEREIN CONTAINS PROPRIETARY INFORMATION OF SULLINS ELECTRONICS AND IS NOT TO BE REPRODUCED, USED OR DISCLOSED TO OTHERS FOR ANY PURPOSE EXCEPT AS SPECIFICALLY AUTHORIZED IN WRITING BY AN OFFICER OF SULLINS ELECTRONICS.

SIZE	DWG. NO.	REV
C	C11127	A

	DESCRIPTION
	CONNECTOR, .100 CC LP
PART NUMBER	--C--DSX--
SCALE: 2:1	SHEET 2 OF 3

PART NUMBER	NO. OF POS.	A ±.008[0.20]		B ±.008[0.20]		C ±.015[0.38]		D ±.010[0.25]		E ±.020[0.51]		F ±.005[0.13]	
		IN	MM	IN	MM	IN	MM	IN	MM	IN	MM	IN	MM
C04DSX *	4	0.300	7.62	0.500	12.70	0.675	17.15	0.975	24.77	1.275	32.39	0.330	8.38
C05DSX	5	0.400	10.16	0.600	15.24	0.775	19.69	1.075	27.31	1.375	34.93		
C06DSX	6	0.500	12.70	0.700	17.78	0.875	22.23	1.175	29.85	1.475	37.47		
C07DSX	7	0.600	15.24	0.800	20.32	0.975	24.77	1.275	32.39	1.575	40.01		
C08DSX	8	0.700	17.78	0.900	22.86	1.075	27.31	1.375	34.93	1.675	42.55		
C10DSX	10	0.900	22.86	1.100	27.94	1.275	32.39	1.575	40.01	1.875	47.63		
C12DSX	12	1.100	27.94	1.300	33.02	1.475	37.47	1.775	45.09	2.075	52.71		
C13DSX	13	1.200	30.48	1.400	35.56	1.575	40.01	1.875	47.63	2.175	55.25		
C15DSX	15	1.400	35.56	1.600	40.64	1.775	45.09	2.075	52.71	2.375	60.33		
C17DSX	17	1.600	40.64	1.800	45.72	1.975	50.17	2.275	57.79	2.575	65.41		
C18DSX	18	1.700	43.18	1.900	48.26	2.075	52.71	2.375	60.33	2.675	67.95		
C19DSX	19	1.800	45.72	2.000	50.80	2.175	55.25	2.475	62.87	2.775	70.49		
C20DSX	20	1.900	48.26	2.100	53.34	2.275	57.79	2.575	65.41	2.875	73.03		
C22DSX	22	2.100	53.34	2.300	58.42	2.475	62.87	2.775	70.49	3.075	78.11		
C23DSX *	23	2.200	55.88	2.400	60.96	2.575	65.41	2.875	73.03	3.175	80.65		
C25DSX	25	2.400	60.96	2.600	66.04	2.775	70.49	3.075	78.11	3.375	85.73		
C26DSX	26	2.500	63.50	2.700	68.58	2.875	73.03	3.175	80.65	3.475	88.27		
C28DSX	28	2.700	68.58	2.900	73.66	3.075	78.11	3.375	85.73	3.675	93.35		
C30DSX	30	2.900	73.66	3.100	78.74	3.275	83.19	3.575	90.81	3.875	98.43		
C31DSX	31	3.000	76.20	3.200	81.28	3.375	85.73	3.675	93.35	3.975	100.97		
C35DSX	35	3.400	86.36	3.600	91.44	3.775	95.89	4.075	103.51	4.375	111.13		
C36DSX	36	3.500	88.90	3.700	93.98	3.875	98.43	4.175	106.05	4.475	113.67		
C40DSX	40	3.900	99.06	4.100	104.14	4.275	108.59	4.575	116.21	4.875	123.83		
C43DSX	43	4.200	106.68	4.400	111.76	4.575	116.21	4.875	123.83	5.175	131.45		
C44DSX	44	4.300	109.22	4.500	114.30	4.675	118.75	4.975	126.37	5.275	133.99		
C49DSX	49	4.800	121.92	5.000	127.00	5.175	131.45	5.475	139.07	5.775	146.69		
C50DSX	50	4.900	124.46	5.100	129.54	5.275	133.99	5.575	141.61	5.875	149.23		
C52DSX *	52	5.100	129.54	5.300	134.62	5.475	139.07	5.775	146.69	6.075	154.31		
C60DSX	60	5.900	149.86	6.100	154.94	6.275	159.39	6.575	167.01	6.875	174.63		
C65DSX	65	6.400	162.56	6.600	167.64	6.775	172.09	7.075	179.71	7.375	187.33		

\* CONSULT FACTORY FOR AVAILABILITY

**PART NUMBER CODING**

**MATERIAL (INSULATOR/CONTACT)**

- E = PBT/PHOSPHOR BRONZE**  
OPERATING TEMP: -65°C TO +125°C  
PROCESSING TEMP: 260°C FOR 10 SECS MAX
- R = PPS/PHOSPHOR BRONZE**  
OPERATING TEMP: -65°C TO +125°C  
PROCESSING TEMP: 260°C FOR 120 SECS MAX
- G = PA9T/PHOSPHOR BRONZE**  
OPERATING TEMP: -65°C TO +125°C  
PROCESSING TEMP: 260°C FOR 120 SECS MAX
- H = PBT/BERYLLIUM COPPER**  
OPERATING TEMP: -65°C TO +125°C  
PROCESSING TEMP: 260°C FOR 10 SECS MAX
- A = PPS/BERYLLIUM COPPER**  
OPERATING TEMP: -65°C TO +150°C  
PROCESSING TEMP: 260°C FOR 120 SECS MAX
- J = PA9T/BERYLLIUM COPPER**  
OPERATING TEMP: -65°C TO +150°C  
PROCESSING TEMP: 260°C FOR 120 SECS MAX
- F = PPS/SPINODAL (CONSULT FACTORY)**  
OPERATING TEMP: -65°C TO +200°C  
PROCESSING TEMP: 260°C FOR 120 SECS MAX  
AVAILABLE IN OVERALL GOLD ONLY (S OR M PLATING CODE)
- C = PPS/BERYLLIUM NICKEL (CONSULT FACTORY)**  
OPERATING TEMP: -65°C TO +200°C  
PROCESSING TEMP: 260°C FOR 120 SECS MAX  
AVAILABLE IN OVERALL GOLD ONLY (S OR M PLATING CODE)
- W = PEEK/BERYLLIUM NICKEL (CONSULT FACTORY)**  
OPERATING TEMP: -65°C TO +250°C  
AVAILABLE IN OVERALL GOLD ONLY (S OR M PLATING CODE)

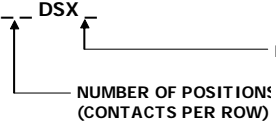

**MOUNTING STYLE**

- H = .125" DIA. CLEARANCE HOLES (PAGE 1)
- I = #4-40 THREADED INSERT (PAGE 2)
- S = .125" DIA. SIDE MOUNTING (PAGE 2)
- N = NO MOUNTING EARS (PAGE 2)
- F = FLOATING BOBBIN (PAGE 2)

**PLATING**

- ALL PLATINGS HAVE .000050" NICKEL UNDERPLATE
- |  |                          |
|--|--------------------------|
| CONTACT SURFACE                          | TERMINATION              |
| G = .000010" GOLD                        | .000005" GOLD            |
| Y = .000030" GOLD                        | .000005" GOLD            |
| B = .000010" GOLD                        | .000100" PURE TIN, MATTE |
| C = .000030" GOLD                        | .000100" PURE TIN, MATTE |
| ** E = .000100" PURE TIN, MATTE, OVERALL |                          |
| S = .000010" GOLD OVERALL                |                          |
| M = .000030" GOLD                        | .000010" GOLD OVERALL    |
- \*\* OVERALL TIN ONLY AVAILABLE ON MATERIAL CODES E, R AND G

ALL PLATINGS ARE LEAD FREE

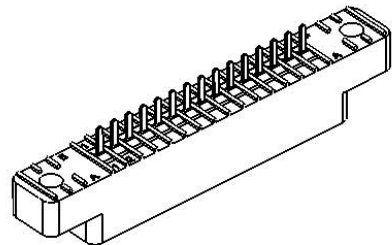

**CUSTOMER COPY**



RoHS COMPLIANT

UNLESS OTHERWISE SPECIFIED:  
DIMENSIONS ARE IN INCHES[MM]  
TOLERANCES:  
ANGULAR: ± 30°  
XX ± .02 [508]  
XXX ± .005 [1270]  
XXXX ± .0005 [0127]  
SURFACE FINISH: 63 Ra  
REMOVE ALL BURRS AND SHARP EDGES .010 MAX

INTERPRET DIMENSIONS AND GEOMETRIC TOLERANCING PER: ANSI Y14.5M-1994

DRAWN	DATE	NAME	
MNH	7-10-08	MNH	
<small>THE INFORMATION HEREIN CONTAINS PROPRIETARY INFORMATION OF SULLINS ELECTRONICS AND IS NOT TO BE REPRODUCED, USED OR DISCLOSED TO OTHERS FOR ANY PURPOSE EXCEPT AS SPECIFICALLY AUTHORIZED IN WRITING BY AN OFFICER OF SULLINS ELECTRONICS.</small>			DESCRIPTION
CONNECTOR, .100 CC LP			PART NUMBER
C - DSX			SIZE DWG. NO
C			C11127
SCALE: 2:1			REV A
SHEET 3 OF 3			